

M12 male 0° / M12 female 0°

TPE 4x18AWG ye UL/CSA, ITC/PLTC 15m

Male straight – female straight

M12 – M12, 4-pole

USA

Plastic housings with good resistance against chemicals and oils.

The resistance to aggressive media should be individually tested for your application. Further details on request.

Further cable lengths on request.

Cable is approved for 600 V

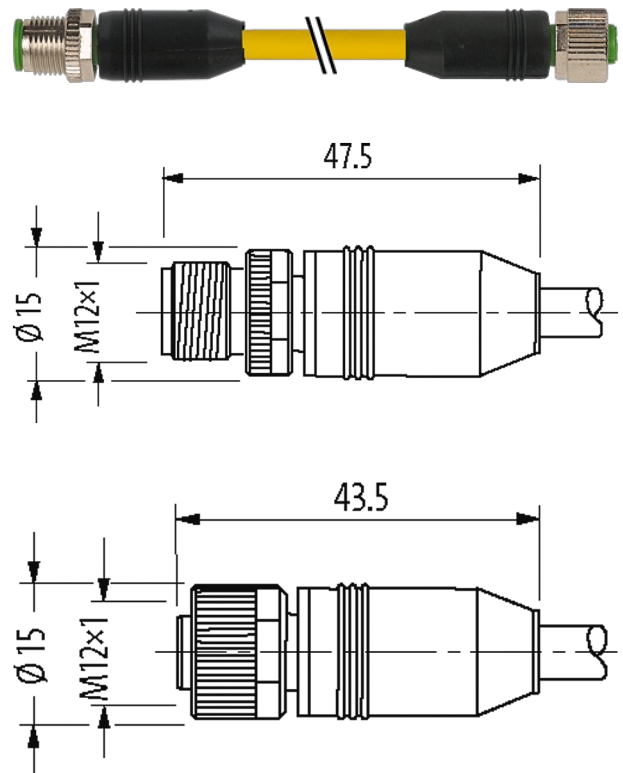
[Link to Product](#)**Illustration**

Product may differ from Image

Approvals

* only for products with UL/CSA approved cable

Form

Form 40021

General data

Standards DIN EN 61076-2-101 (M12)

Mounting method inserted, tightened

Pollution Degree 3

Temperature range -25...+85 °C, depending on cable quality

Cables	
No./diameter of wires	4 × 0.75 mm ²
Wire isolation	PVC (br, wh, bl, bk)
C-track properties	10 Mio.
Material (jacket)	TPE (UL/CSA)
Outer Ø	7.2 mm ±5%
Bend radius (moving)	15 × outer Ø
Temperature range (fixed)	-40...+105 °C
Temperature range (mobile)	-20...+90 °C
Cable identification	150
Cable Type	TPE
Approval (cable)	UL (AWM-Style 20626/10708), CSA; CE conform
Cable weight [g/m]	78,57
Material (wire)	Cu wire, bare
Resistor (core)	max. 22.5 Ω/km (20 °C)
Single wire Ø (core)	0.234 mm
Construction (core)	19 × 0.254 mm (multi-strand wire class 5)
Diameter (core)	4 × AWG18/19
Material (wire isolation)	PVC
Wire-Ø incl. isolation	1.93 mm ±5%
Color/numbering of wires	br, bk, bl, wh
Stranding combination	4 wires twisted
Shield	no
Material (jacket)	TPE
Outer-Ø (jacket)	7.2 mm ±5%
Color (jacket)	yellow
thermal resistance	flame retardant
Nominal voltage	600 V AC
Test voltage	4000 V
Current load capacity	to DIN VDE 0298-4
Temperature range (fixed)	-40...+105 °C
Temperature range (mobile)	-20...+90 °C
Bend radius (fixed)	10 × outer Ø
Bend radius (moving)	15 × outer Ø
No. of bending cycles (C-track)	max. 10 Mio. (25 °C)
Torsion stress	±180°/m
No. of torsion cycles	max. 3 Mio. (25 °C)
Jacket Color	yellow
Technical Data	
Operating voltage	max. 250 V AC/DC
Operating voltage (only UL listed)	max. 30 V AC/DC
Rated surge voltage	2.5 kV
Operating current per contact	max. 4 A
Material group	IEC 60664-1, category I
No. of poles	4
Coding	A-coded
Locking of ports	Screw thread (M12×1 mm) recommended torque 0.6 Nm, self-securing
Compression gland	M12 (SW13)

Protection	IP65, IP66K, IP67 inserted and tightened (EN 60529)
Locking material	Zinc die casting, matte nickel plated
suitable for corrugated tube (internal Ø)	without

Commercial data

country of origin	DE
customs tariff number	85444290
EAN	4048879574570
eClass	27279218
Packaging unit	1

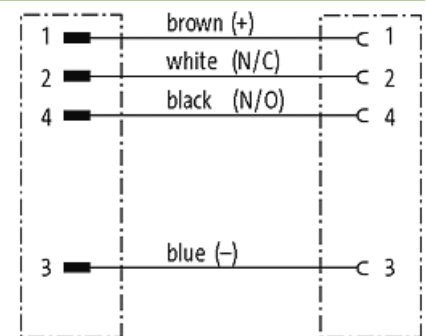
Sketch

Male

Female

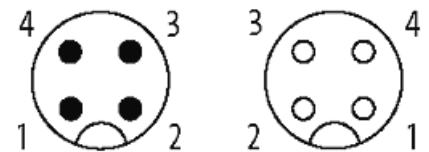

Product may differ from Image